

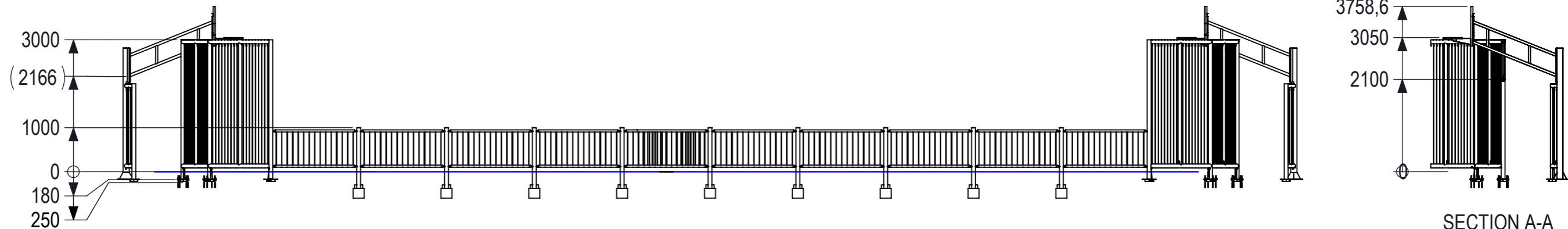

All rights reserved. Reproduction
 without permission is prohibited.
 In welke vorm ook, is zonder schriftelijke
 toestemming van de afzender niet geoorloofd.
 authority from the proprietor.

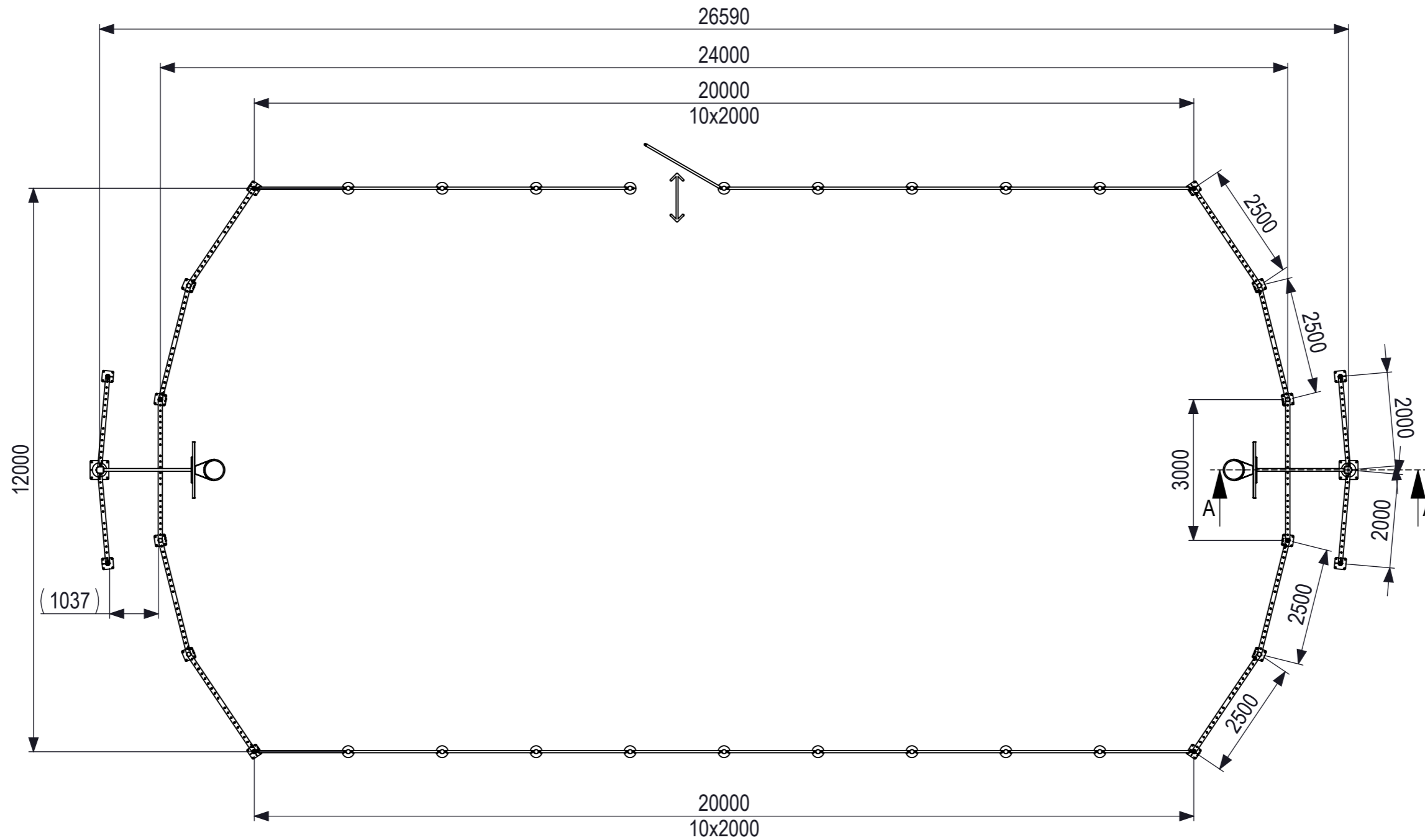



80
70
60
50
40
30
20
10
0
mm

SECTION A-A

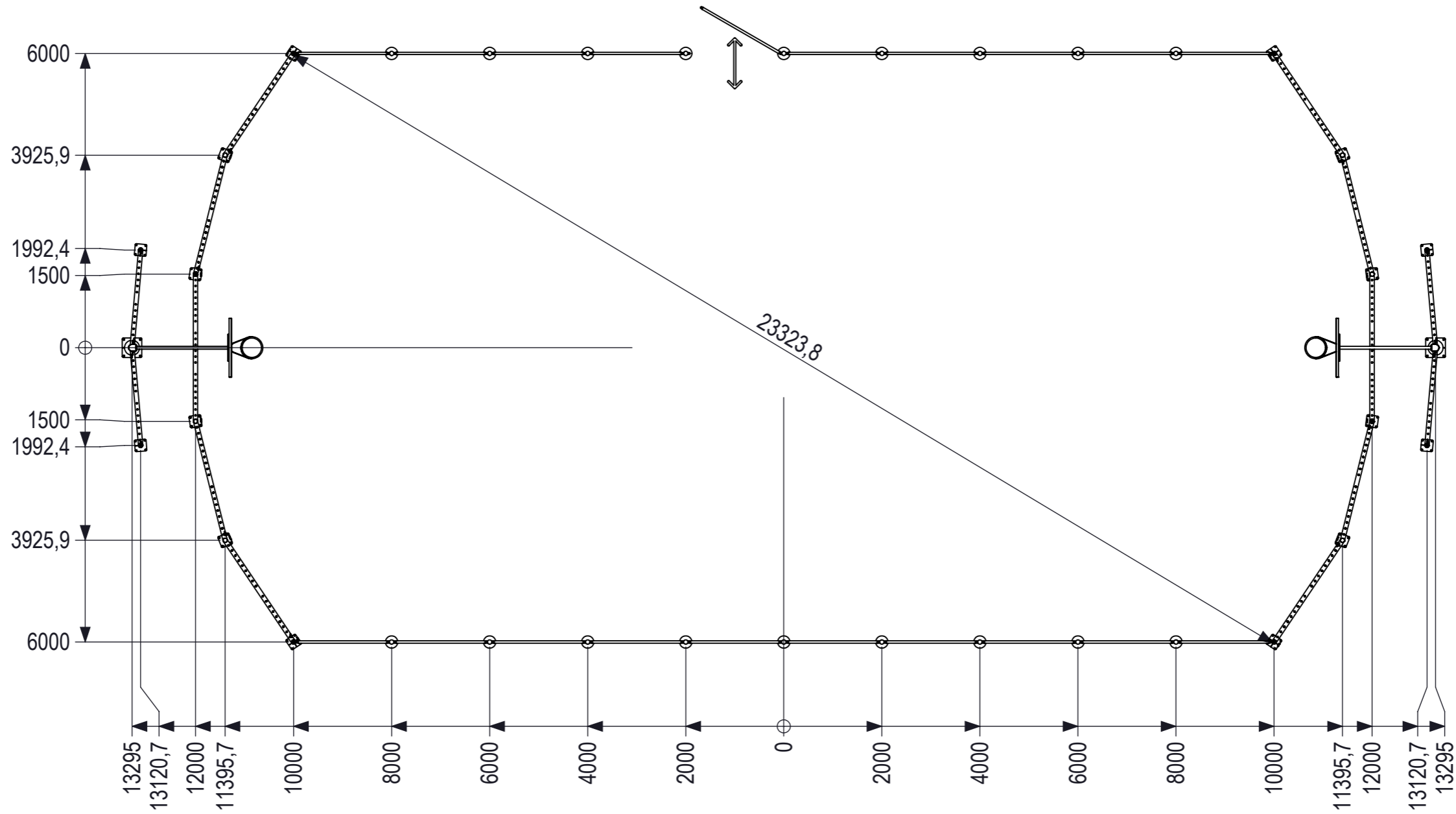
 IJSLANDER Oude Dijk 10 8096 RK Oldebroek The Netherlands T +31 (0)525 633420 F +31 (0)525 631067 info@ijslander.com www.ijslander.com	oppervlakte ruwheid surface roughness DIN ISO 1302 <input checked="" type="checkbox"/> <input checked="" type="checkbox"/> <input checked="" type="checkbox"/>	alg. ruwheid gen. roughness 3.2	eenheid/unit mm	datum date 16-3-2023	naam name JvdK
	vorm- en plaatstoleranties geometrical tolerancing DIN ISO 1101 <input type="checkbox"/> <input type="checkbox"/> <input type="checkbox"/> <input type="checkbox"/> <input type="checkbox"/> <input type="checkbox"/>	alg. toleranties gen. tolerancing DIN 7168-m	toelaatbare afwijkingen voor lineaire maten (m.u.v. gebroken kanten) admissible deviations for linear dimensions (excepting broken edges)	getekend drawn 3089.98	gewicht weight kg
proj. 	benaming/name Citybox Arena 24x12x3/1m	lineaire maat linear dimension afwijking/deviation	>= 0,5 6 30 120 400 1000 2000 4000 8000 ±0.1 ±0.2 ±0.3 ±0.5 ±0.8 ±1.2 ±2 ±3	oppervlakte behandeling/surface treatment -	blad/sheet wijz./rev. form./size
schaal/scale 1:100	tekeningnummer/drawingnumber 4009	materiaal/material -	1-3	00	A3



 <p>Ijlander BV Oude Dijk 10 8096 RK Oldebroek The Netherlands T +31 (0)525 633420 F +31 (0)525 631067 info@ijlander.com www.ijlander.com</p>	oppervlakte ruwheid surface roughness DIN ISO 1302	alg. ruwheid gen. roughness 3.2	eenheid/unit cm	datum date 16-3-2023	naam name JvdK																		
	vorm- en plaatstoleranties geometrical tolerancing DIN ISO 1101	toelaatbare afwijkingen voor lineaire maten (m.u.v. gebroken kanten) admissible deviations for linear dimensions (excepting broken edges)																					
alg. toleranties gen. tolerancing DIN 7168-m	<table border="1"> <thead> <tr> <th>lineaire maat linear dimension</th> <th>> 0,5</th> <th>6</th> <th>30</th> <th>120</th> <th>400</th> <th>1000</th> <th>2000</th> <th>4000</th> </tr> </thead> <tbody> <tr> <td>afwijking/deviation</td> <td>±0.1</td> <td>±0.2</td> <td>±0.3</td> <td>±0.5</td> <td>±0.8</td> <td>±1.2</td> <td>±2</td> <td>±3</td> </tr> </tbody> </table>					lineaire maat linear dimension	> 0,5	6	30	120	400	1000	2000	4000	afwijking/deviation	±0.1	±0.2	±0.3	±0.5	±0.8	±1.2	±2	±3
lineaire maat linear dimension	> 0,5	6	30	120	400	1000	2000	4000															
afwijking/deviation	±0.1	±0.2	±0.3	±0.5	±0.8	±1.2	±2	±3															
proj. 	omschrijving/description Citybox Arena 24x12x3/1m		Totaal gewicht: kg	Zwaarste onderdeel: kg	Leefijd van: jaar	Valondergrond klasse:																	
schaal/scale 1:100	tekeningnummer/drawingnumber 4009			blad/sheet 2 - 3	wijz./rev. 	form./size A3																	

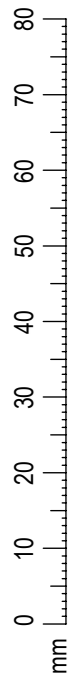

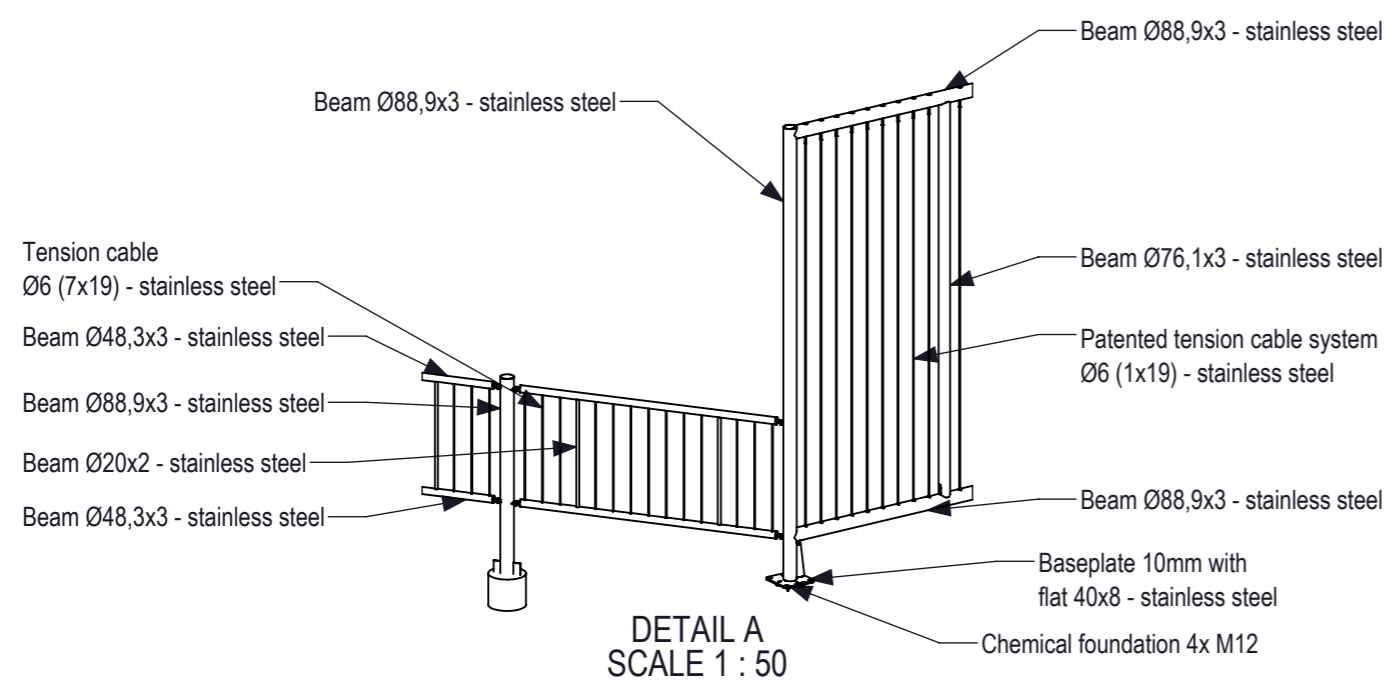
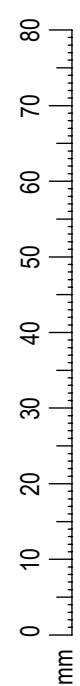
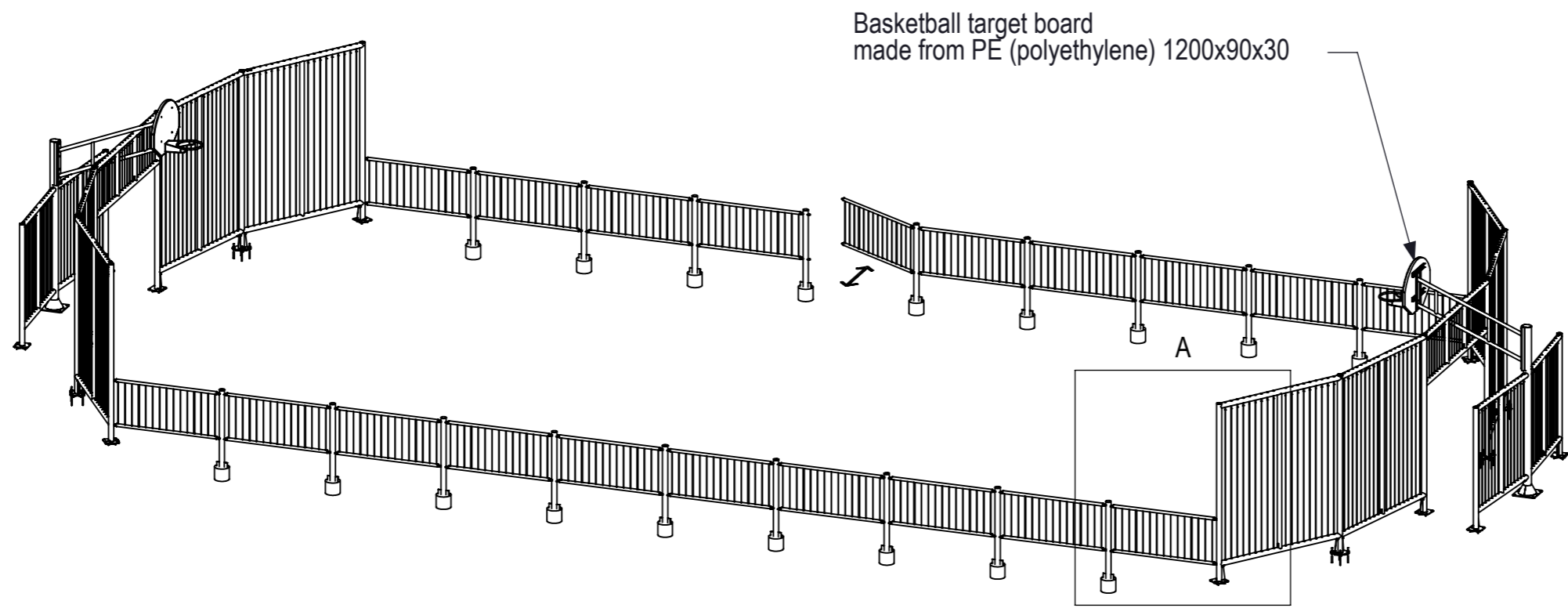

<p>IJSLANDER BV Oude Dijk 10 8096 RK Oldebroek The Netherlands T +31 (0)525 633420 F +31 (0)525 631067 info@ijslander.com www.ijslander.com</p>	oppervlakte ruwheid surface roughness DIN ISO 1302	alg. ruwheid gen. roughness 3,2	eenheid/unit cm	datum date 16-3-2023	naam name JvdK					
	vorm- en plaatoleranties geometrical tolerancing DIN ISO 1101	toelaatbare afwijkingen voor lineaire maten (m.u.v. gebroken kanten) admissible deviations for linear dimensions (excepting broken edges)								
alg. toleranties gen. tolerancing DIN 7168-m	lineaire maat linear dimension	afwijking/deviation	> 0,5 ≤ 6 ±0.1	6 30 ±0.2	30 120 ±0.3	120 400 ±0.5	400 1000 ±0.8	1000 2000 ±1.2	2000 4000 ±2	4000 8000 ±3
proj. 	omschrijving/description Citybox Arena 24x12x3/1m		Totaal gewicht: kg	Zwaarste onderdeel: kg	Leeftijd van: jaar	Valondergrond klasse:	tekeningnummer/drawingnumber 4009	blad/sheet 3 - 3	wijz./rev. 	form./size A3
schaal/scale 1:100										