





| | | | | | |
|---|--|--|----------------------------|---|--------------------------|
|  <p>IJSLANDER</p> | | <p>Ijlander BV Oude Dijk 10 8096 RK Oldebroek The Netherlands T +31 (0)525 633420 F +31 (0)525 631067 info@ijlander.com www.ijlander.com</p> | | <p>benaming/name Butterfly</p> | |
| | | <p>proj. </p> | <p>eenheid/unit cm</p> | <p>datum/date 29-1-2020</p> | <p>naam/name JdJ</p> |
| <p>schaal/scale 1:50</p> | <p>tekeningnummer/drawingnumber 1320-R03-INS</p> | | <p>wijz./rev. -</p> | <p>form./size A3</p> | |

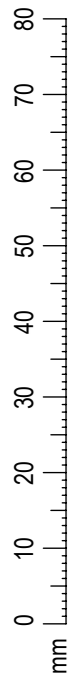
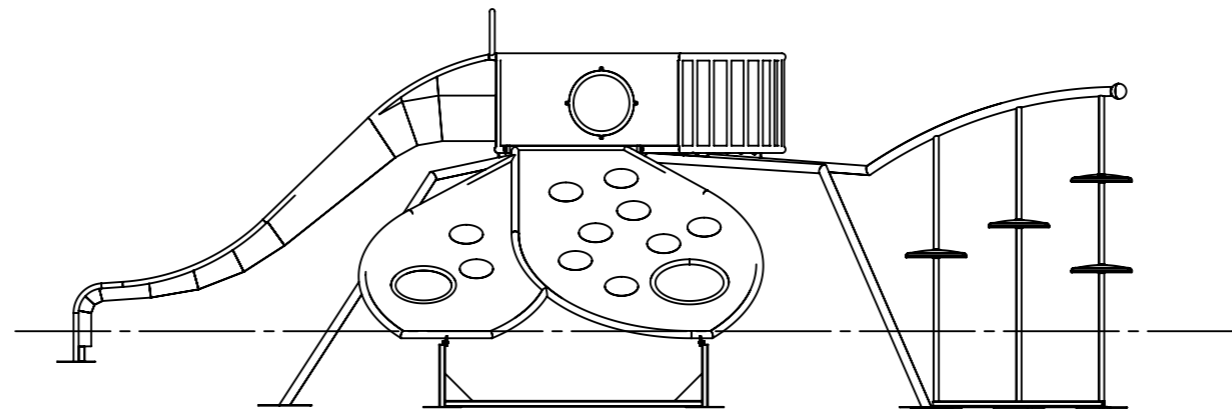
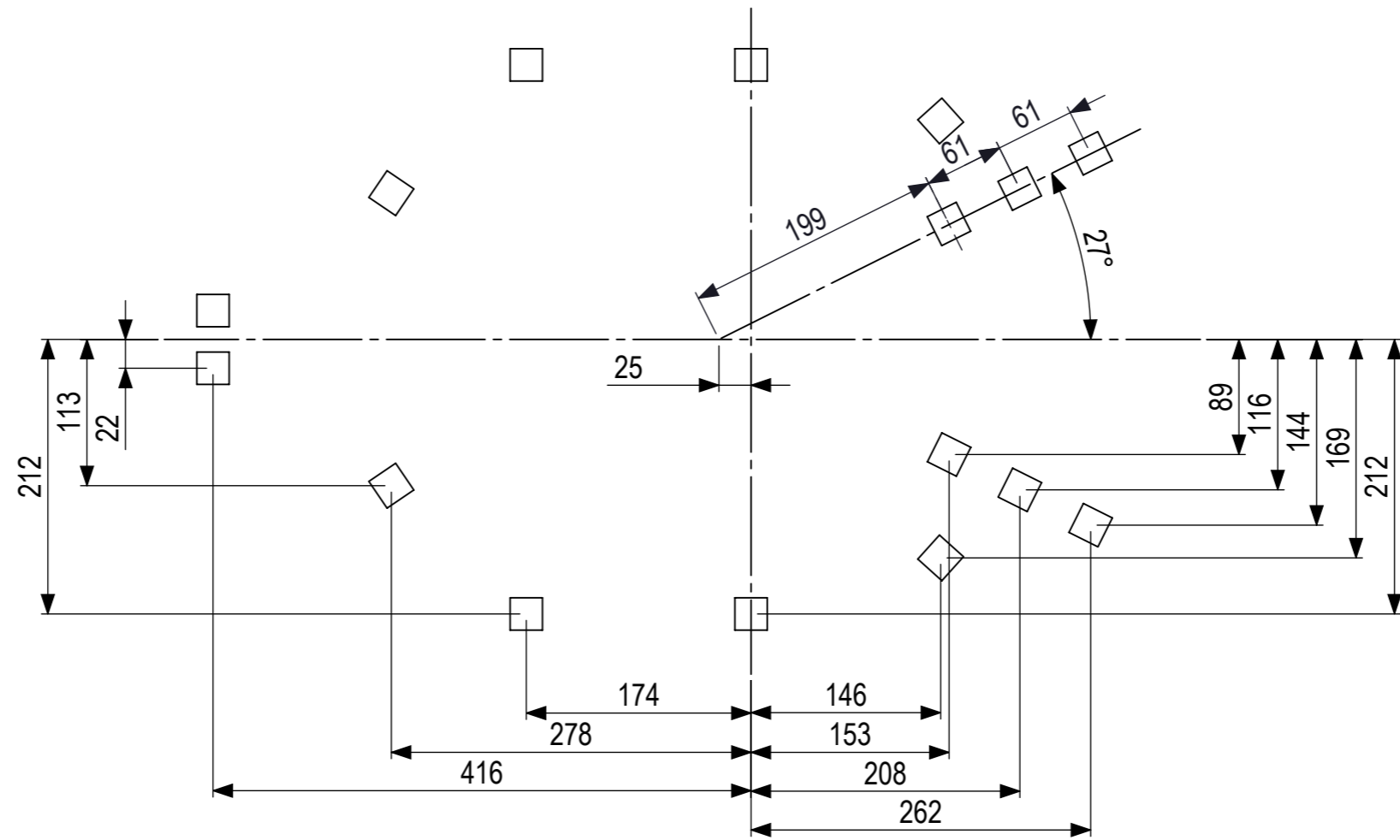

| | | | | | | | |
|---|--|---|--------------------|---|----------------------------|---------------------|---------------------|
|  <p>IJSLANDER</p> | | <p>Ijlander BV Oude Dijk 10 8096 RK Oldebroek The Netherlands T +31 (0)525 633420 F +31 (0)525 631067 info@ijlander.com www.ijlander.com</p> | | benaming/name <h2 style="text-align: center;">Butterfly</h2> | | | |
| | | proj.  | eenheid/unit CM | getekend drawn JdJ | datum date 29-1-2020 | naam name JdJ | paraaf signature |
| schaal/scale 1:50 | | tekeningnummer/drawingnumber 1320-R03-INS | | | blad/sheet 2 - 2 | wijz./rev. | form./size A3 |